

Mindful of the environment, health, and the future

HUMAN TECHNOLOGY

COWAY DIGITAL BIDET



3 things you need for a healthier life



Eating well, getting good sleep, and having regular bowel movements: three essential conditions for a healthier and longer life. These are three simple, yet very important activities that define much of our health.

Directly linked to our survival, defecation is considered to be just as important as sleeping and eating.

It is said that people who have defecation problems are rarely healthy.

Well—Eating

Well—Sleeping

Well—Defecation

How much of your life is spent using the toilet?



27,375 TIMES
912 HOURS



206,955 TIMES
6,898 HOURS

Average life span of 30 OECD countries : Man-75 years / Woman- 81 years
Average Usage Frequency : Man-1/Day , Woman-7/Day
Average time span of toilet use-2 minutes



Blocked up?



People might joke about having problems in the defecation department, but for those who suffer the consequences, it is no laughing matter. Many feel embarrassed, and remain silent about anal and rectal diseases.

Anal and rectal diseases are no longer just a matter of personal embarrassment. They are becoming more and more common. Thorough and careful hygiene can act as prevention and treatment for these diseases.

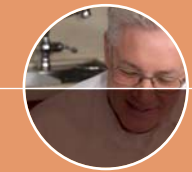
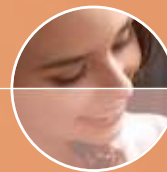
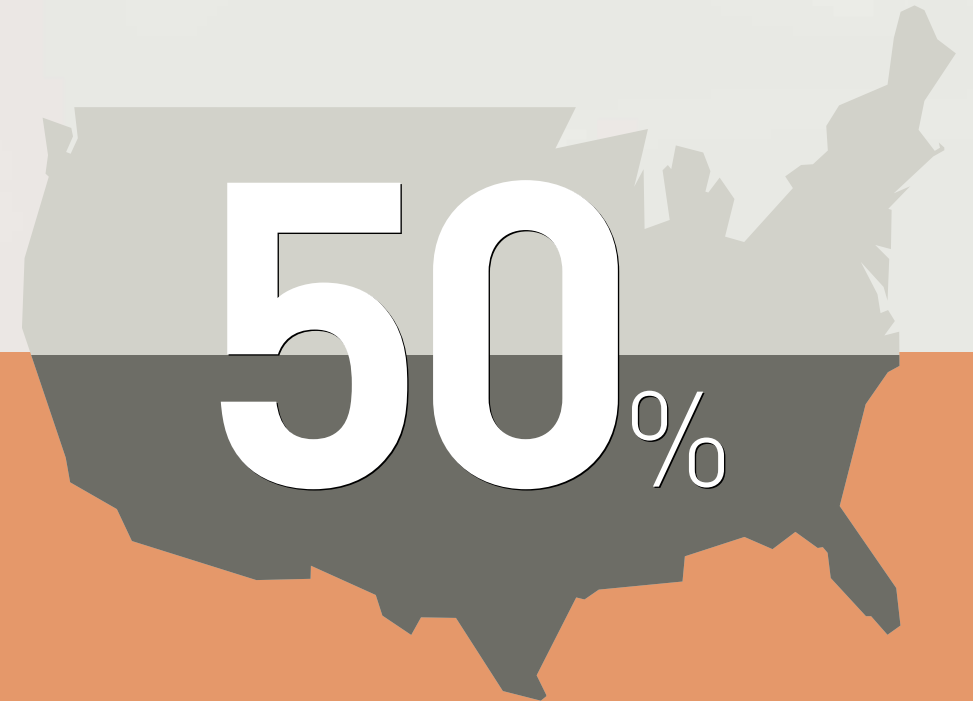

1
2

According to the National Institute of Health, about half of the U.S. population over 50 have anal and/or rectal diseases.
Source: U.S. Food and Drug Administration <http://www.fda.gov>

What is your daily routine?



- Do you have a long commute to your job?
- Are you stressed out from your work?
- Do you often eat or drink heavily?
- Do you have to sit for long periods of time while studying?
- Do you bring a magazine or newspaper with you when you go to the bathroom?
- Are you bothered by loose bowels?
- Do you have prolonged periods between bowel movements because of constipation?
- Are you pregnant?
- Do you practice golf, weight training or mountain climbing to relieve pressure in your stomach?

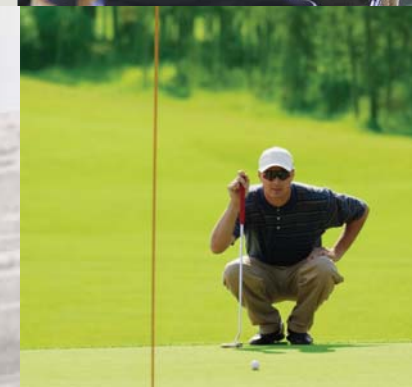
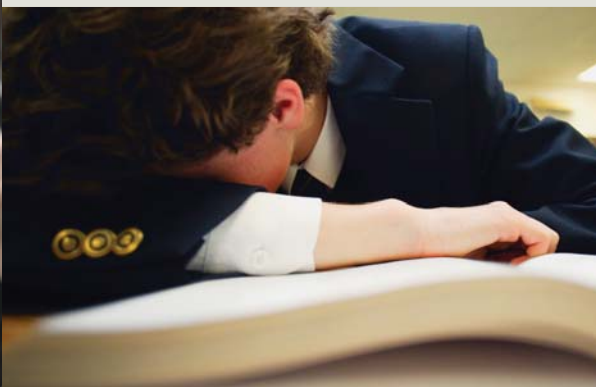

5 types of common anal diseases. Perhaps this has happened to you, too?



Anal Fissure
Pain during defecation, or even for hours afterward. Visible tears in the anus. Blood on the stool, toilet paper or in the toilet bowl. Constipation, burning, possibly painful itching.



Hemorrhoids
Bleeding during defecation, but without pain in anus. Anus swells and causes pain, regardless of defecation. Skin tags can be felt by the hands. Irritation when walking.



Anal Fistula
Fatigue, fever, and swollen anus. A little convex hall around anus. Leaves pus on underwear.



Rectal Prolapse
Difficult to control feces or gas. Slick liquid on underwear. Feces as big as an egg.



Pruritus Ani
Itching and stinging around the anus. Ooze from inflammation. Anus turns lustrous.

Is your toilet adequate for your hygiene and health?

Advanced toilet technology can help you achieve healthy bowel movements. The anus is the last exit of the digestive system, and must be kept clean both for your health and for your comfort. You can buy drinking water when the water supply is out of order. But what if the sinkhole breaks?



We brush our teeth after every meal to maintain our dental health. But we don't give enough care to the anus, which is equally important.

You are never perfectly clean with toilet paper

Wrinkles in the rectal area are difficult to clean

Hazardous fluorescent brightening

Agents on toilet paper can cause possible transmission of bacteria

The elderly and the sick cannot properly clean with toilet paper

Have you ever cleaned your hands with paper, rather than water?

Dry toilet paper cannot effectively clean your delicate surfaces after defecation. The rectal and genital areas consist of more than a thousand sensitive wrinkles, and toilet paper can hardly clean this area completely. This means that you cannot manage your anal hygiene with only toilet paper. The use of dry paper can lead to irritation, and will never clean you completely. Over time, this can cause bacteria growth and infections. Paper is just a good way of spreading bacteria around, which can lead to hemorrhoids, and possibly bladder, and urinary tract infections. Continuing to clean with dry paper will only lead to irritation of these sensitive areas, along with increased bleeding and itching of the affected area. This scenario does not happen to everyone, but many people can relate to the problems that dry toilet paper can cause. So stop using toilet paper - it's a great way to save a tree.



The use of bathroom tissue is sometimes not enough.



Viral infection is a possibility through the use of bathroom tissues.



Bathroom tissues are sometimes insufficient in the thorough cleaning of stool.



Feces can be remained in pores or in anal wrinkles.

Civilization's gift to women, the electronic bidet

By cleaning and protecting the feminine areas, the bidet helps greatly in the prevention of feminine diseases.

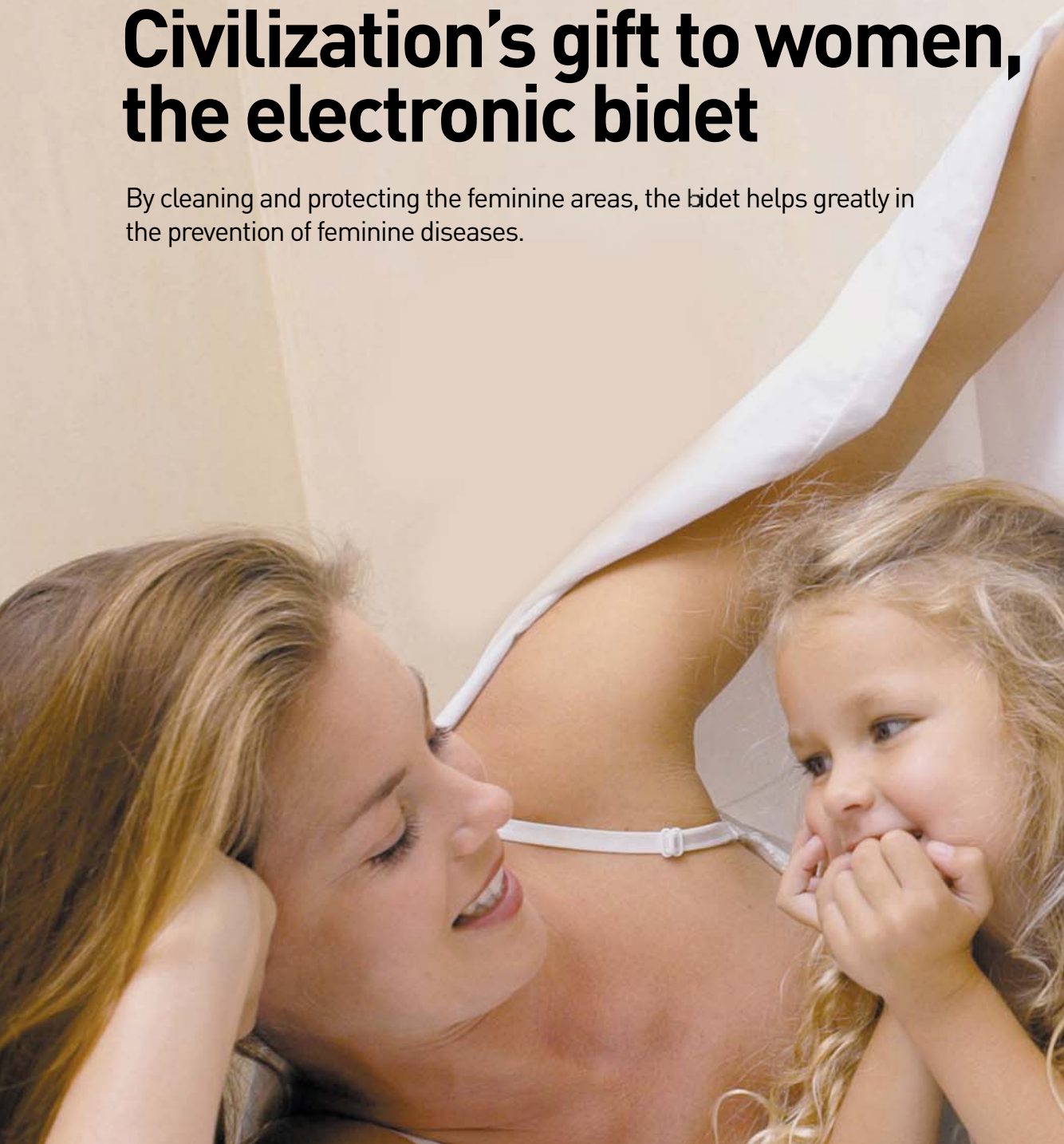

Clean and
sanitizing

Maintain
personal
hygiene

Clean and sanitizing

A bidet provides gentle cleansing and massaging of the sensitive rectal and genital areas. A hip bath is also available. The Coway digital bidet has a filter, which is not available on competitors' products.

Maintain personal hygiene

Toilet paper is not effective in cleaning genital and rectal areas. In addition, the use of toilet paper encourages the proliferation of Bacteria and Parasites, which promote bladder and maternity diseases. A bidet can help prevent Urethritis, Cystitis, and Urinary abnormalities.



Benefits of electronic bidet

Hemorrhoid and constipation prevention

Typically, 8 out of 10 people have problems with Hemorrhoids and Constipation. The warm water washing and air-drying of a bidet stimulate the surrounding capillaries, increasing blood circulation, reducing pain and creating a smoother bowel movement.

Blood lump protection

A bidet can even wash away lumps of blood with high-pressure water. This means the sensitive wrinkles of the rectal area can be washed off thoroughly.

Hypertension, obesity, disabilities, children, etc.

Blood moves to the head during a bowel movement, so people with hypertension and obesity are not able to bend to use toilet paper. A bidet is also beneficial for children and people with disabilities.

Daily habits that lead to better anal health

Maintain anal hygiene

Itching and inflammation can be caused by an unclean anus. The use of warm water is more effective than the use of dry toilet paper. Using warm water to rinse gently is good for internal hemorrhoids. Do not use any soap, and carefully dry after washing.

Keep your waist and hips warm

A cold waist or cold hips can lead to poor blood circulation. Make sure to dress accordingly to stay warm. Mini skirts, short pants, and tight underwear are prone to accelerate anal diseases.

10 minutes of hydrotherapy per day

Form a habit of having hydrotherapy on a daily basis. Hydrotherapy can be done simply by dipping your hips in warm water. Perform hydrotherapy for 10 to 15 minutes. Another way to accomplish this is to dip only the lower half of your body in a bathtub filled with warm water.

Defecate within 10 minutes

When undergoing bowel movements, spend no more than 10 minutes at a time. Under normal conditions, feces should come out within 1 minute. It is recommended to finish the deed within 3 minutes.



Revolution of Toilet Culture

Toilet culture is evolving... more convenience with disease prevention!

As humans have evolved, so should toilet culture.



For you who care about your health! For healthy toiletry!

DIGITAL BIDET IS THE CHOICE

tip Bidet is a personal cleansing method utilizing a stream of water, which is more hygienic and beneficial than toilet paper. The word bidet was first used in the 15th century to refer to the pet ponies kept by the French royalty. During the 19th century, the Europeans developed a porcelain cleaning device for contraceptive and purgative (cathartic) uses, which was called a bidet because its shape resembled those ponies. Over time, its use has evolved more into a personal cleansing method, paralleling the improved sanitation and the heightened sense of personal hygiene in the modern world.

HUMAN TECHNOLOGY
COWAY DIGITAL BIDET
well-being system



You care about your health, and the health of your loved ones. Coway digital bidet provides the cleaner and fresher care that you need.



HUMAN TECHNOLOGY / COWAY DIGITAL BIDET

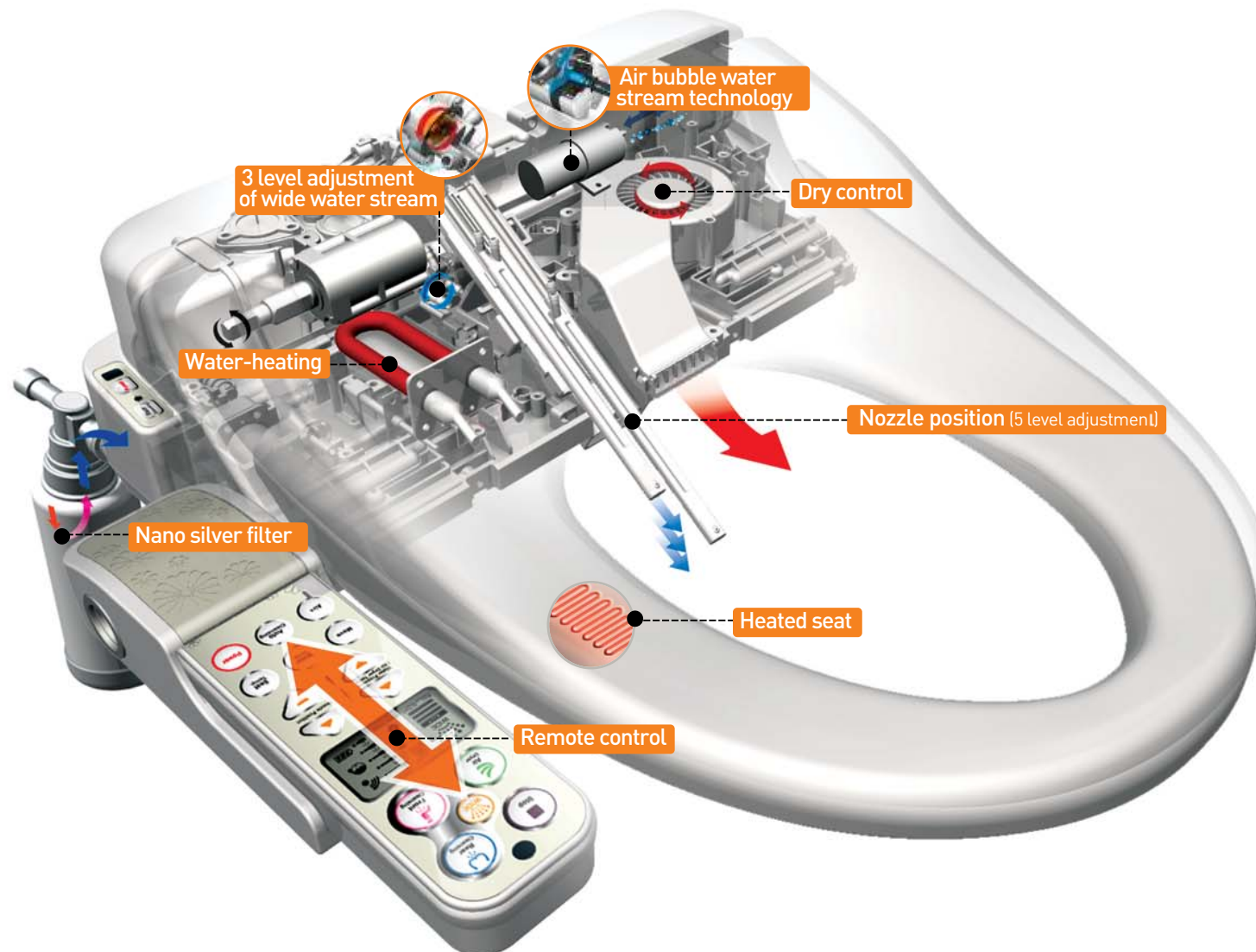

FOR HYGIENE

- Wide Water Stream
- Air + Water Stream
- Nano silver ceramic filter
- Twin nozzles
- Self-cleaning nozzle
- Nozzle cleaning

FOR CONVENIENCE

- Dry control
- Heated seat
- Self-testing
- Automatic nozzle movement
- Auto cleansing
- Mute mode

FOR ENERGY CONSERVATION

- Auto power-saving mode
- Seat locking mode

FOR UNIVERSAL DESIGN

- Ergonomic seat
- 5 levels of nozzle position adjustment
- Remote control

FOR SAFETY

- Engineered for your safety
- Soft open / close

FOR HYGIENE/ NANO SILVER CERAMIC FILTER

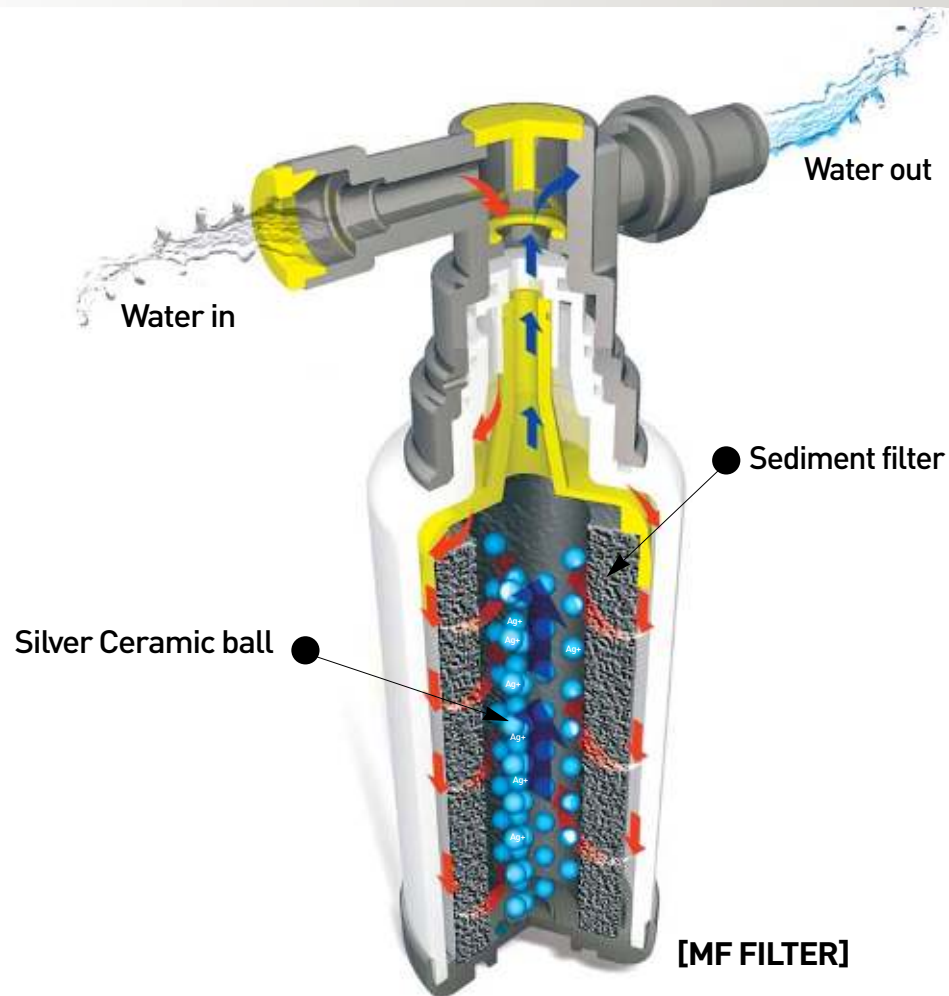

Refreshing Your Mind



Nano silver filter for water purification

The silver ceramic ball filter, made of naturally sterilizing elements, ensures the water used for cleansing and bidet are pure and clean.

FOR HYGIENE/ WIDE WATER STREAM TECHNOLOGY

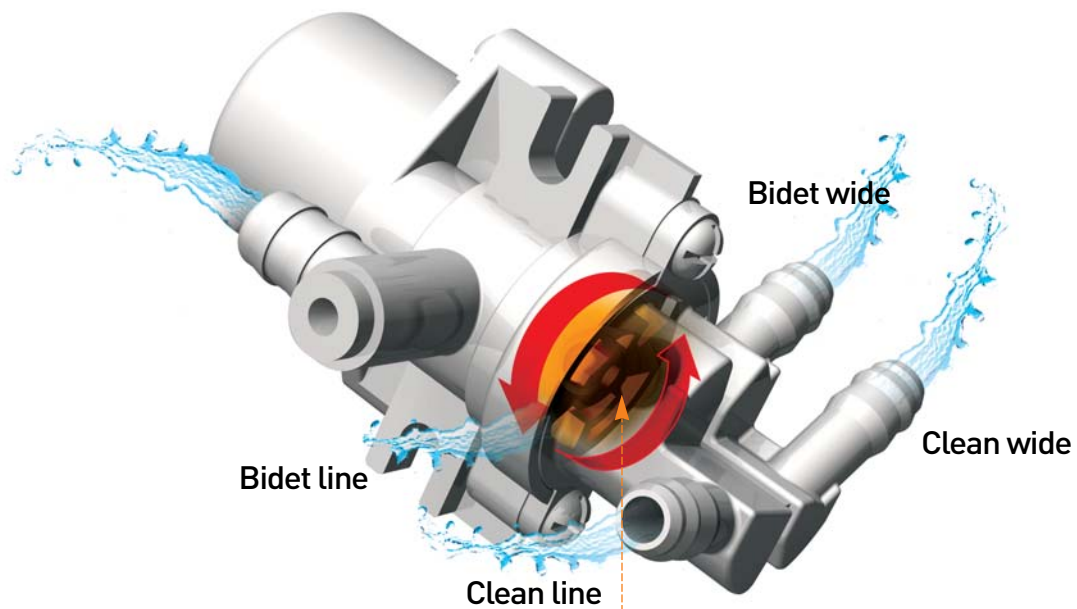

[4WAY valve system]

The 4-way valve system, only available from Coway, is able to adjust the water stream to 20 different types from a single nozzle, perfectly customized to individual need

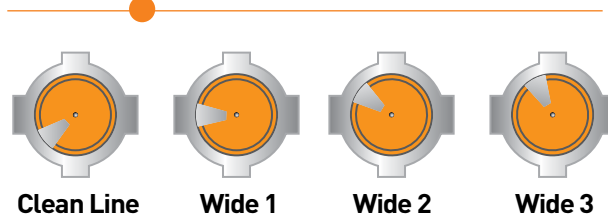

Invisible Cleanness

3 level adjustment of wide water stream

From a straight linear spray for intensive cleansing to a fountain-type wide spray for soft and gentle cleansing, 3 different levels of spray help you to take care of your family's health.

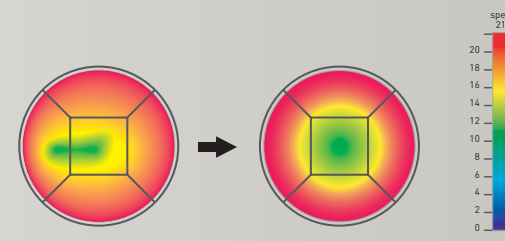

A special nozzle controls the distribution of the water stream, enabling precise management of location and water stream strength.

FOR HYGIENE/ AIR + WATER STREAM TECHNOLOGY

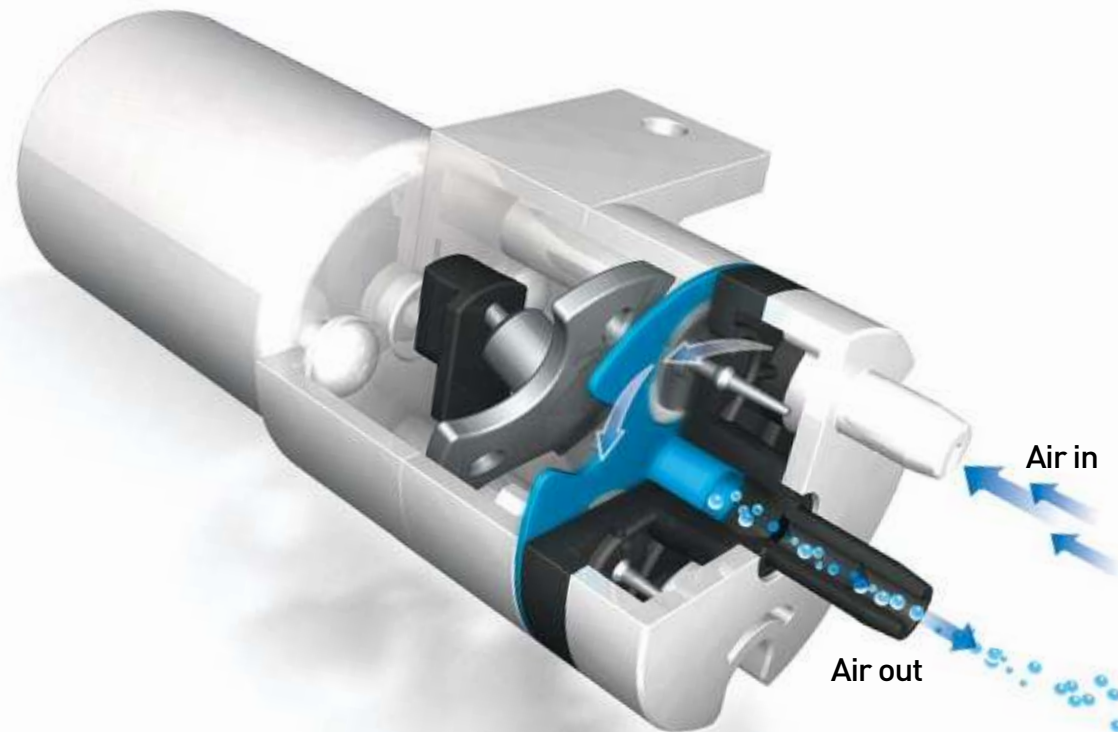

Invisible Cleanness

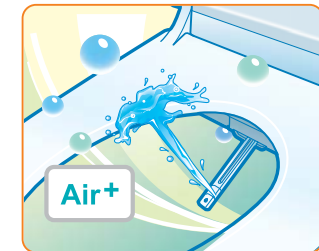

Air + Water stream

With a technology that combines air bubbles, this evolutionary cleaning method makes cleansing all the more powerful, while reducing water consumption by fifty percent. The air pump inserts air bubbles into the cleansing water, and smoothens the stream of water for the bidet. The air bubbles blow off when they touch human skin, helping skin become clean.

FOR CONVENIENCE/ **DRY CONTROL, HEATED SEAT**

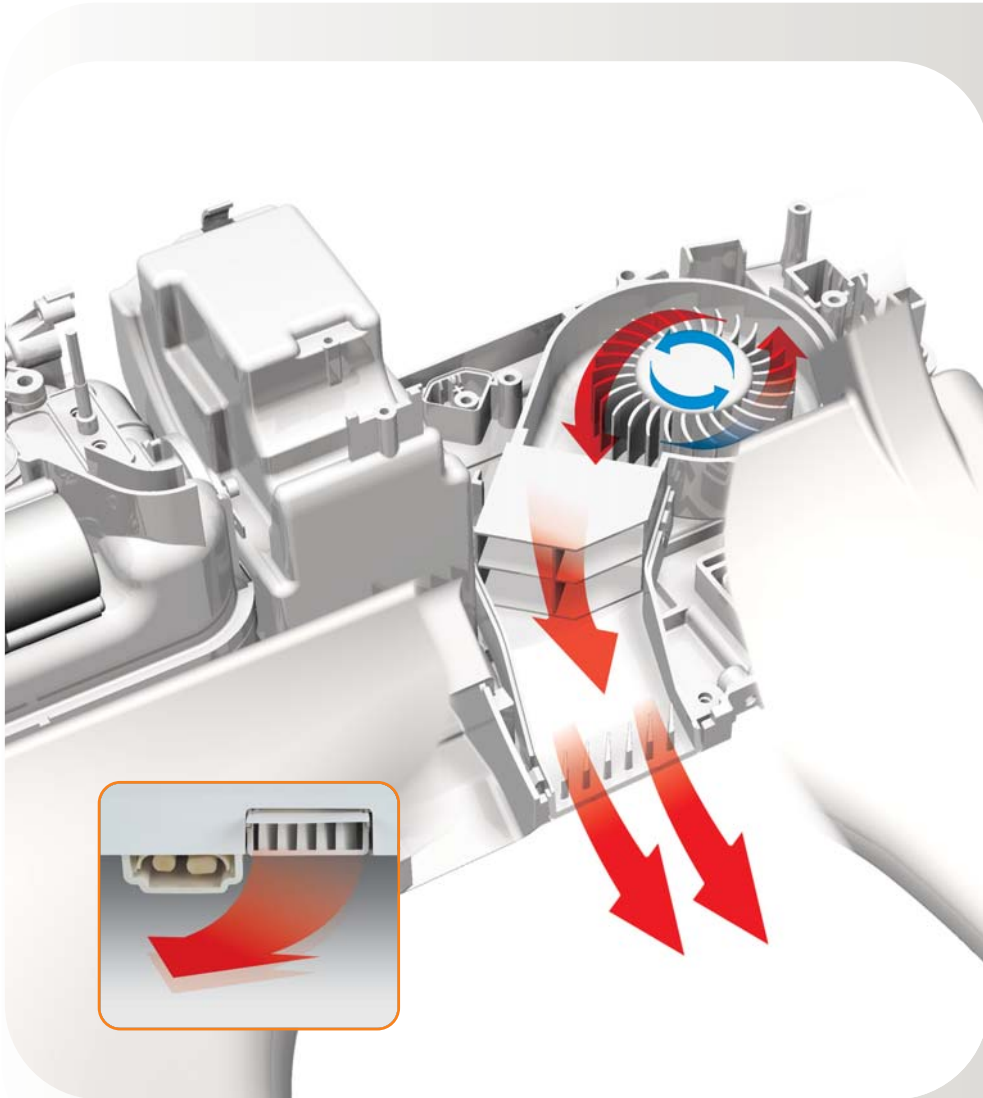

A little thing that makes a big difference



Heated seat

The temperature control device maintains comfort for your hips.



Dry control

After the cleansing is complete, the temperature-adjustable dry air guarantees a refreshing finish.

UNIVERSAL DESIGN/ **ERGONOMICS, REMOTE CONTROL**

Technology with more care

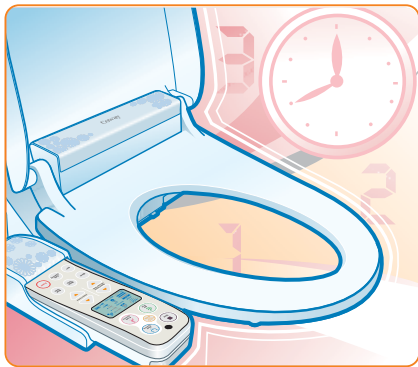

ERGONOMIC SEAT

The ergonomic design allows comfort for extended use.



REMOTE CONTROL

This controls the product, and is designed to provide the user with the utmost convenience.



NOZZLE POSITION (5 Level Adjustment)

You can freely adjust the position of the nozzle to suit your individual needs.



ENGINEERED FOR YOUR SAFETY

The product is engineered for safe use in wet environments.

ADVANTAGES OF COWAY BIDET



AUTO POWER-SAVING MODE

The product enters power-save mode if the control is idle for 30 minutes and no user is detected by the sensor. Once in power-save mode, the water and seat temperature is set to 'low', and the LED on the main area is switched off.

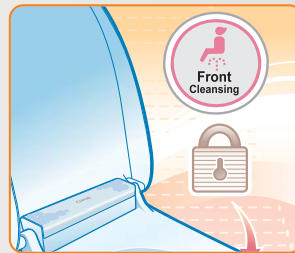

SEAT LOCK MODE

If the sensor does not detect a user through the seating sensor, the rear cleansing, front cleansing, air drier, and auto cleansing features are locked from operation.

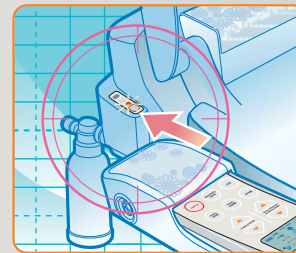

SELF-TESTING

The LED on the main body flashes when a problem occurs, while setting off the buzzer to alert the user.



AUTO-CLEANSING

With a single touch, the user can conveniently run the 'rear cleansing' and 'air drier' features.

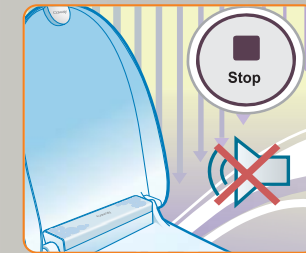

MUTE MODE

When this mode is selected, the keys operate silently. This is not the initial setting. The default setting uses a buzzer to notify the user of the status.



TWIN NOZZLES

The anal cleansing nozzle and female bidet nozzle are separated for a more hygienic operation.

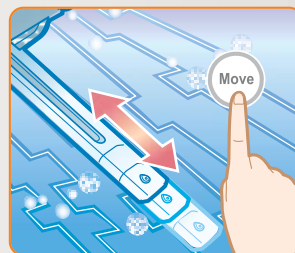

MOVE

Select the 'move' function during rear or front cleansing to toggle the nozzle forward or backward for a more thorough cleansing.



SELF-CLEANING NOZZLE

After the rear or front cleansing is complete, the nozzle is automatically sprayed with cleansing water for 5 seconds to maintain nozzle cleanliness.



NOZZLE CLEANING

The nozzle is extended to its maximum length for cleaning.



WHO CAN BENEFIT FROM USING A COWAY DIGITAL BIDET?



Benefits for Female Hygiene

The bidet is a great way for a woman to feel confident, secure, refreshed, and completely clean. The warm, gentle water flow has a wide range of settings, allowing a comfort suitable to every woman's needs. The warm cleansing water is beneficial during menstruation, or after intercourse.

The warm water cleansing is a good way to help alleviate problems that can occur after pregnancy, such as rashes, constipation, and the soreness and bleeding that come from diarrhea and hemorrhoids.



Benefits for Children's Hygiene

Children are always catching colds, and are prone to viruses because they always seem to be getting dirty! The Bidet is even gentle enough that a child can use it.

The proper supervision of an adult is necessary, but teaching a child to use a bidet is a good way to instill the importance of good personal hygiene at an early age. This can allow children to grow up without the problems that many adults have to deal with today.



Benefits for Male Hygiene

The bidet is a great way for a man to feel confident, secure, refreshed, and completely clean.

A warm cleansing, along with the air dryer, allows for a hands-free encounter. The bidet is a great way to help alleviate the problems associated with soreness from hemorrhoids, rectal itching, and constipation.





WHO CAN BENEFIT FROM USING A COWAY DIGITAL BIDET?

Benefits for Senior Citizens' Hygiene

The bidet has many advantages for seniors. Because it is a hands-free device, seniors will no longer need the help of a care giver for those moments when they may feel ashamed. This will allow seniors to have a feeling of liberation and confidence, that they will not require assistance when they need to clean up. The warm water cleaning the rectal area, and the dry air cleaning with no need for toilet paper, will restore the self-confidence that they may have lost.

Benefits for the Hygiene of the Disabled, or Handicapped

Because the bidet is hands-free it has excellent benefits for those who are handicapped or disabled. Think of how a handicapped person's self-confidence can be restored, knowing that they can use the restroom without having someone to clean up after them. The warm water cleanses the rectal area, followed by the warm air dryer, so there is no need for toilet paper.



COWAY DIGITAL BIDET

BA-07



BA-07

Three Different Water Stream Widths

There are three levels available for the spray mode, which toggles from a more direct stream to a more diffused spray, enabling intensive cleansing of a focused area or soft cleansing of a broader area, respectively.

Move Function

When move mode is selected, the nozzle traverses back and forth so as to achieve a delicate cleansing.

Adoption of MF Filter (Nano Silver Ceramic Filter for Healthy Cleansing)

Featuring natural substances, a silver ceramic ball has the ability to resist bacteria and disinfect during the water purification process. The end result is a more sanitary water to use in the bidet.

Self-diagnosis Function

The LED on the operation panel blinks to alert the user when a malfunction is detected in the product.

Ergonomic Design

The product is designed for safe and comfortable use.

| MODEL | | BA-07 |
|-------------------|---------------------|---|
| Cleansing time | | Maximum 0.2gal/min (0.7l/min), Self-cleansing nozzle |
| Bidet time | | Maximum 0.2gal/min (0.7l/min), Self-cleansing nozzle |
| Warm seat | Off | Room Temperature: 68°F (20°C) |
| | On | Low: 93.2°F (34°C) Medium: 96.8°F (36°C) High: 100.4°F (38°C) |
| Warm air drier | Temperature control | 3 levels |
| | Operating time | 2min |
| Filtration | | MF Type |
| Power consumption | | 850W (Max.) |
| Operating noise | | 37.0 ~ 48.0 db |
| Dimension | BA07-R | 19.3(W)X5.9(H)X20.1(D) inch [490(W)X150(H)X510(D) mm] |
| | BA07-E | 19.3(W)X5.9(H)X20.1(D) inch [490(W)X150(H)X540(D) mm] |
| Net Weight | | 12.81 lb (5.7kg) |

BA-08



BA-08A

BA-08A

Three Different Water Stream Widths

There are three levels available for the spray mode, which toggles from a more direct stream to a more diffused spray, enabling intensive cleansing of a focused area or soft cleansing of a broader area, respectively.

Move Function

When move mode is selected, the nozzle traverses back and forth so as to achieve a delicate cleansing.

Powerful Washing Performance

The high-pressured "bubble wash" feature provides the user with improved cleansing performance.

Self-diagnosis Function

The LED on the operation panel blinks to alert the user when a malfunction is detected in the product.

Detachable Controller

Remote controller brings convenience to the user.

| MODEL | | BA-08A | BA-08B |
|-------------------|-----|--|---|
| Cleansing time | | Maximum 0.2gal/min (0.7l/min) Self-cleansing nozzle | Maximum 0.2gal/min (0.7l/min) Self-cleansing nozzle |
| Bidet time | | Maximum 0.2gal/min (0.7l/min) Self-cleansing nozzle | Maximum 0.2gal/min (0.7l/min) Self-cleansing nozzle |
| Warm seat | Off | Room Temperature: 68°F (20°C) | Room Temperature: 68°F (20°C) |
| | On | Low: 93.2°F (34°C) Medium: 98.6°F (37°C) High: 104°F (40°C) | Low: 91.4°F (33°C) Medium: 96.8°F (36°C) High: 102.2°F (39°C) |
| Warm air drier | | Temperature control : 3 Level Operating time : 2 min | Off : Room temperature Low: 89.6°F (32°C) High: 96.8°F (36°C) |
| Filtration | | MF Type | |
| Power consumption | | 850W | 850W |
| Operating noise | | 37.0 ~ 48.0 db | |
| Dimension | | BA08-AR : 20.7(W)X5.6(H)X19.7(D) inch [525(W)X142(H)X500(D) mm] | BA08-BR : 20.7(W)X5.6(H)X19.7(D) inch [525(W)X142(H)X500(D) mm] |
| | | BA08-AE : 20.7(W)X5.6(H)X20.9(D) mm [525(W)X142(H)X530(D) mm] | BA08-BE : 20.7(W)X5.6(H)X20.9(D) mm [525(W)X142(H)X530(D) mm] |
| Kids seat size | In | | 5(W)X6.9(D) inch [127(W)X175(D) mm] |
| | Out | | 14.8(W)X15.5(D) inch [376(W)X393(D) mm] |
| Net Weight | | BA08-AR : 13.7 lb (6.2kg) BA08-AE : 15.0 lb (6.8kg) | 21.8 lb (9.9kg) |

BA-08B (Kids Bidet)

Melody Kit

Melody kit plays children's songs and classical music to give comfort and pleasure to kids when using a bidet

Child Seat

The detachable child seat is delicately designed for kids and equipped with a safe handle

Child-focused design

The nozzles and water pressure are adjusted to children



BA-08B



FOR BETTER WORLD, BETTER FUTURE, AND YOUR DREAM

Scope of Business

Coway will never stand still, and will continue to grow as an environmental enterprise with integrity for its customers.



Water Filtration Devices

Coway's water filtration devices ensure clean and healthy water with advanced technology such as reverse osmosis filtration system.

Air Purifiers

Coway's wellness air purification system completely eliminates all indoor air pollutants such as fine dust, bacteria, and even bad odors.

Bathroom Appliances

Coway has been leading Korea's bathroom culture through the cleaner and fresher care of digital bidets and water softeners.

Home Appliances

Coway also provides premium home appliances such as multi-cookers, megasonic cleaning device, food waste treatment system, humidifiers, oxygen generators, and vacuum cleaners.

Investment in R&D is the Key to Superior Products and Services



Investment in R&D is the Key to Superior Products and Services

Behind the astonishing growth and development of Coway lie painstaking efforts by researchers striving to be the world's best. In the company's early years, even before our first factory was built, an Environmental Technology Institute was established to engage in research, and product and technology development. Since that time, Coway has developed the world's leading water filtration devices, air purifiers, bidets, and water softeners. Coway also has accumulated unique expertise in the field of environmental and health appliances, including water filtration systems with a Reverse Osmosis Filter.



Coway's manufacturing facilities promise trust and reliability

A well-organized production process, thorough testing and inspection, and the spirit of true scientists helps us bring strong products to our customers. Coway operates production facilities in several cities in South Korea. Our annual production capacity amounts to 1.7 million water filtration units, 487,000 air purification units, and 10.5 million water filter units and other related parts.

Our well-organized production system for each process ensures the manufacture of perfect products. Moreover, any parts with imperfections are controlled by our computer system to support after-sales service and management.



Quality control

Coway will become a world-class company that creates superior value

Guinness Book of Records Coway Co.,Ltd.



In September 1995, Coway became the first Korean company to obtain this certificate. The certificate recognizes entities that properly use knowledge and technology for water quality improvement and operate with honesty, sincerity and integrity based on WQA Ethics Principles.

Global Brand Competency Index Number 1



GBCI (Global Brand Competency Index) No.1 for 3 consecutive year (2004~2006) for Coway, Looloo and Cairns from JMAC (Japan Management Consultants)

GBCI : Global brand rating index by International Consulting Firm, JMAC. This brand index research is done in 8 of the world's leading countries including Japan, the U.S, France, China, and Korea, with the same rating standards to score the brand management level of each company in an industry.

Winner of the Korea Marketing Grand Prize for five consecutive years



In 2001, Coway was awarded the "Grand Marketing Prize" by the Korean Management Association. The company won in the Market Leadership Activity category for its exceptional performance in the area of marketing strategy and activities, and a company-wide survey based on market-oriented thinking.

ISO 9001 Certification



Coway's quality control system was certified by TUV, the world's leading third-party inspection organization. TUV Bayern was founded in Germany in 1872 to carry out product development, design, manufacturing, inspection, testing, installation and services.

ISO 14001 Certification



Coway has worked to protect the environment, through efforts such as operating Korea's largest research center for environmental technology, home to some 170 scientists. The company has passed the TUV Bayern Group's ISO 14001 inspection and has been recognized for its environment-friendly management system.

WQA Certified Water Quality Specialist



This is to certify that Coway Co., Ltd., established in 1989, has an annual production of 700,000 units and total sales of 1,300,000 units, and is the greatest corporate enterprise of water purification system in the Republic of Korea.



No. 1 in Brand Power

The Korea-Brand Power Index (K-BPI) indicates the influence of a brand being marketed in Korea on consumers' purchasing behavior. It was developed in 1998 by KMA Consulting Inc. Coway has ranked at the top of this index for seven consecutive years, from 1999 through 2005.

We Bring Wellness
Coway FOR BETTER WORLD, BETTER FUTURE, AND YOUR DREAM

GLOBAL NETWORK

Created by Coway's exceptional core technology, our highly competitive products are popular in more than 30 countries around the world. As the world's largest specialist in water purifier and the leading company in health and environmental appliance, we have developed a product line that meets the diversified needs of global consumers through ongoing research on environment-friendly home appliances, and the development of diverse product categories.